

PCB LAYOUT

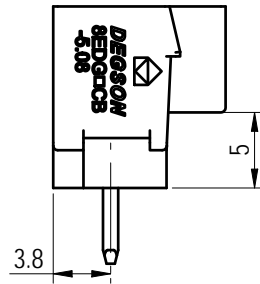
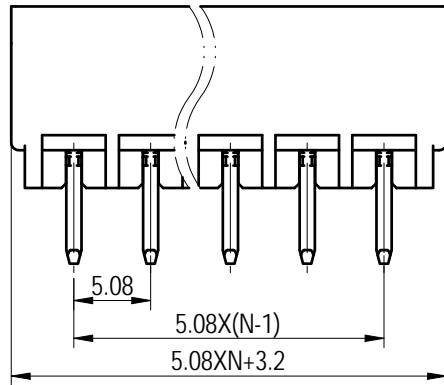
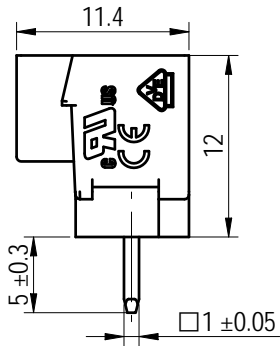
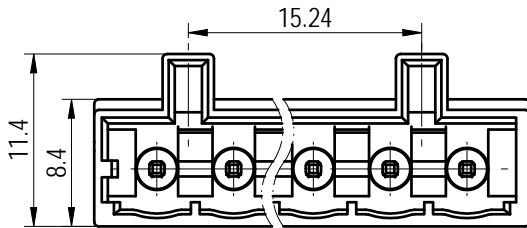
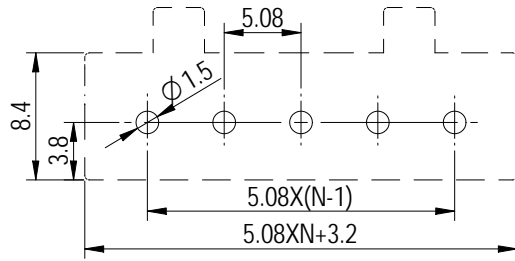

未注公差/General tolerances (mm)

0 ~ 3	>3 ~ 6	>6 ~ 10	>10 ~ 18	>18 ~ 30	>30 ~ 50	>50 ~ 80	>80 ~ 120	>120 ~ 180	>180 ~ 250	>250 ~ 315	>315 ~ 400	>400 ~ 500	>500	0.1/10
±0.12	±0.18	±0.22	±0.26	±0.31	±0.37	±0.57	±0.80	±0.93	±1.05	±1.15	±1.60	±2.20	±2.50	±2'

2P

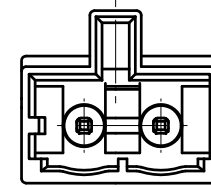

3P

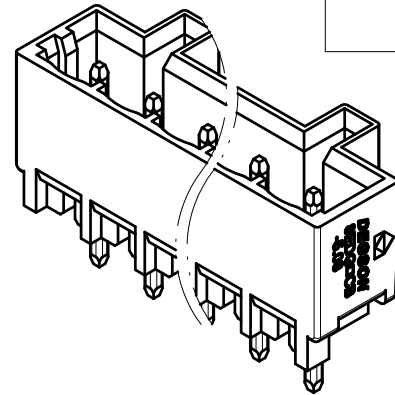
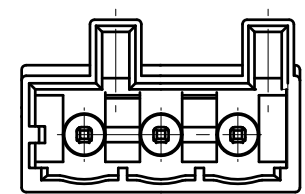

2	Pin	Copper	Sn Plated
1	Housing	PA66	UL94V-0
ITEM	NAME OF PART	MATERIAL	NOTES
UL 标准/UL Standard:			B C D
额定电压/电流/Rated Voltage(V)/Current(A)			300/15 / 300/10
IEC 标准/IEC Standard:			
过压类别/Overtoltage Category/污染等级/Pollution Degree			III/3 III/2 IV/2
额定电压/电流/Rated Voltage(V)/Current(A)			320/20 / /
额定脉冲电压(KV)/Rate Impulse Voltage(KV)			4 / / /
间距/Pitch(mm)/线数范围/Poles			5.08/N=02~24P
使用温度范围/Operating temperature(°C)			-40~+105
符合RoHS环保要求/Conform to RoHS			Yes

		MATERIAL:	SURFACE/COLOR: PANTONE 7534U		
		MAT NO./REV:	/ 00 MAT STATUS: 批量		
APPD: 兰春华	2024.11.29	NAME			
CHKD: 龚耀志	2024.11.29	8EDGVCB-5.08-XXP-11-01A&Z(H)			
DRFT: 牛泰	2024.11.29	DRAWING NO.	TYPE	DRAWING STATUS	SCALE
		200320550	CUSTOMER DRAWING	已发布	2:1
				SHEET	1/1

00			牛泰	2024.11.29
REV	ECN	DESCRIPTION	DRFT	DATE

Transfer or duplication of this document as well as the utilization or communication of its contents are prohibited unless authorized in writing by DEGSON. All rights reserved for patent. 除专利注明情况外，其他部分均不作为要约。 未经授权，禁止以任何形式复制或传播。 未经授权，不得将本文件的内容用于任何目的。 未经授权，不得将本文件的内容用于任何目的。 未经授权，不得将本文件的内容用于任何目的。